

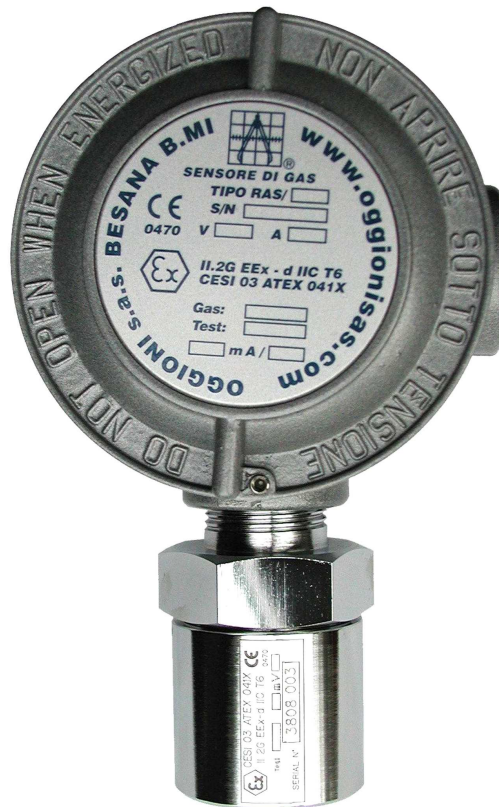

®

enose[®] RAS/AD GAS TRANSMITTER

enose[®] Technology



INSTALLATION AND OPERATING INSTRUCTIONS

Printed in Italy
October 2013
Rev.4.6

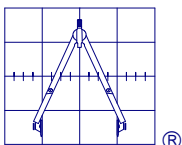

OGGIONI S.a.s. Via Lavoratori Autobianchi, 1 - 20832 Desio (MB) Italy
Tel. +39 0362 629135 Fax.+39 0362 622531 e-mail: info@oggionisas.com
On-line support techsupport@oggionisas.com - web: www.oggionisas.com



Atex Certified

Copyright

The technical documentation in this manual is an OGGIONI s.a.s. Publication and the use thereof are reserved for users of the system. Complete or partial reproduction for any other use other than support material for users of the system is forbidden without specific, written authorisation from OGGIONI s.a.s.

Registered Trademark

OGGIONI and the logo OGGIONI s.a.s. enose® are registered trademarks of OGGIONI s.a.s.
MODBUS is registered trade mark of Gould Inc.
BLUETOOTH is a registered trademark of Bluetooth SIG.Inc. U.S.A.

Oggioni reserves the right to change published specifications and designs without prior notice!

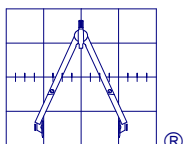

OGGIONI S.a.s. Via Laboratori Autobianchi, 1 - 20832 DESIO (MB) Italy
Tel. +39 0362 629135 Fax.+39 0362 622531 e-mail: info@oggionisas.com
On-line support techsupport@oggionisas.com - web: www.oggionisas.com



Table of Contents

WARRANTY STATEMENT	3
WARNINGS and CAUTIONS	3
USE AND RESTRICTIONS.....	3
I INTRODUCTION	3
1.1 General Description.....	3
1.2 Features	3
1.3 Typical Application.....	3
II SPECIFICATION	3
2.1 General specification.....	3
2.2 Electrical Specification.....	3
2.3 Environmental Specification	3
2.4 Mechanical Specification	3
2.5 Ordering information.....	3
2.6 Outline drawing.....	3
III INSTALLATION.....	3
3.1 Sensor Location Guidelines.....	3
3.2 Generic wiring guidelines.....	3
3.3 Guide lines for proper installation according to EMC Directive.....	3
3.4 General precautions.....	3
3.5 Storage.....	3
3.6 Cable connection guidelines.....	3
3.7 Final inspection and Start Up	3
3.8 Fault conditions and Actions	3
IV TEST AND VERIFICATION	3
V CALIBRATION	3
5.1 ZERO Calibration.....	3
5.2 SPAN Calibration.....	3
5.2.1 Span calibration with relay outputs (CCS)	3
5.2.2 Span calibration using an multimeter	3
VI MAINTENANCE	3
VII MODBUS RTU Serial Interface.....	3
7.1 Introduction	3
7.2 Modbus read command	3
7.3 Memory map	3
VIII MARKING AND CERTIFICATIONS.....	3
IX ACCESSORIES	3

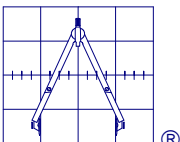

OGGIONI S.a.s. Via Lavoratori Autobianchi, 1 - 20832 DESIO (MB) Italy
 Tel. +39 0362 629135 Fax.+39 0362 622531 e-mail: info@oggionisas.com
 On-line support techsupport@oggionisas.com - web: www.oggionisas.com



WARRANTY STATEMENT

Warranty

Oggioni S.a.s. warrants that all items delivered under this agreement will be free from defects in material and workmanship, conform to applicable specifications, and, to the extent that detailed designs have not been furnished by the buyer, will be free from design defects. Oggioni S.a.s. shall not be liable for the goods being fit for a particular purpose. The above warranty is given by Oggioni S.a.s. subject to the following conditions:

Oggioni S.a.s. shall not be liable in respect of any defect in the goods arising from any design or specification supplied by the buyer;

Oggioni S.a.s. shall not be liable under the above warranty if the total price for the goods has not been paid by the time period specified in charter 6 of the present conditions of sales.

The above warranty does not extend to parts, materials or equipments manufactured by or on behalf of the buyer unless such warranty is given by the manufacturer to Oggioni S.a.s.

If so required by Oggioni S.a.s. the Products will be returned to Oggioni S.a.s. by the buyer at the buyer's risk and expense;

This warranty does not cover defects in or damage to the products which are due to improper installation or maintenance, misuse, neglect or any cause other than ordinary commercial application. Any claim by the buyer which is based on any defect in the quality or condition of the goods or their failure to correspond with specifications shall be notified to Oggioni S.a.s. within 24 months from the date of delivery, unless otherwise specified by Oggioni S.a.s. in writing.

Where any valid claim in respect of any goods which is based on any defect in the quality or conditions of the goods or their failure to meet specifications is notified to Oggioni S.a.s. in accordance with this conditions, Oggioni S.a.s. shall be entitled at Oggioni S.a.s.' sole discretion to either replace the goods free of charge or repair the goods. If Oggioni S.a.s. is neither ready nor able to either repair or replace the goods the buyer shall be entitled at the buyer's sole discretion to claim for a reduction of price or the cancellation of the contract.

Limitation of Liability

The warranty is in substitution for and shall replace all conditions and warranties on the part of Oggioni S.a.s. implied by statute or common law or otherwise all of which are expressly excluded (insofar as they may be excluded by law) and Oggioni S.a.s. shall not be liable whether in contract, tort or otherwise in respect of defects or in damage to the products or for any injury loss or damage of whatever kind attributable to such defects or damage.

Note that: it is the buyer's responsibility to satisfy itself that the products are suitable for its requirements and Oggioni S.a.s. does not profess to have any skill or judgement in relation to the particular needs of the buyer. The buyer shall be deemed to have full knowledge of the nature and properties of and shall carry out its own testing of the accuracy and performance of the products.

If Oggioni S.a.s. is found liable for any loss or damage suffered by the buyer that liability shall be limited to the price of the products hereunder and in no event shall Oggioni S.a.s. be liable for any loss of profit or any other commercial loss including but not limited to special incidental consequential or other loss or damage.

Although Oggioni S.a.s. will use its best endeavours to ensure that any figure published by Oggioni S.a.s. relating to the performance of the product are accurate, Oggioni S.a.s. does not warrant the accuracy of any published performance figure.

When ordering goods to Oggioni S.a.s. the buyer undertake burden to be in knowledge of all legal limitations and applications and security norms about use of supplied goods. It is therefore excluded any responsibility of Oggioni S.a.s. about use, wrong use, impossibility of use of supplied devices; compensation requests for direct or indirect damages caused by use, wrong use, impossibility of use of supplied devices for whatever reason will thereby not be possible.

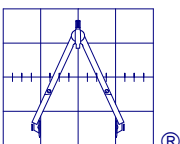

OGGIONI S.a.s. Via Lavoratori Autobianchi, 1 - 20832 DESIO (MB) Italy
Tel. +39 0362 629135 Fax.+39 0362 622531 e-mail: info@oggionisas.com
On-line support techsupport@oggionisas.com - web: www.oggionisas.com



WARNINGS and CAUTIONS

The RAS series transmitters are designed to continuously analyze toxic or explosive gas in the atmosphere. They may be used in hazardous areas with explosion hazard in the range 0-100% LEL. The analysis unit may use catalytic, solid state or NDIR technology transducers.

The transmitters have a 4-20mA standard engineered output or alternatively three threshold outputs associated to the Alarm, Warn and Fault conditions.

These devices are an integral part of gas detection fixed installations, to protect industrial plants and the workers safety



Before using the enose[®] transmitters make sure you have read and understood the operating and installation instructions in the present manual.

Improper use of these products, as well as the inadequate maintenance of the same, can compromise the efficiency jeopardizing the safety of the controlled environments and users.

Improper use of the equipment described in this manual or a use out of manufacturer's specification, as well as unauthorized modification of the product will be considered NON-COMPLIANCE with invalidation of any form of guarantee.

USE AND RESTRICTIONS

The flammable gas transmitters equipped with catalytic sensors CANNOT be used in inert atmosphere or in oxygen deficiency.

As prescribed in the European Standard EN 60079-29-2 the minimum concentration of oxygen present in the environment, for a proper device operation, must be **> del 10% v/v.**

Always about the use of catalytic sensors, we must recall that there are substances that can significantly influence the sensor response.

These substances are called poisoning, the most common are:

Silanes, silicates, silicones.

Halides (compounds containing fluorine, chlorine, bromine and iodine)

Sulphur glycols (compounds that polymerize the sensor catalytic element)

Heavy Metals (ex. Tetraethyl lead).

If these substances may be present, it is recommended to often verify the sensor sensibility performing a calibration test.

The sensor is exposed to the atmosphere to be analyzed through an entrance protected by a sintered steel filter, having a flame-break function.

This filter has to be maintained clean, protected by water infiltrations or by powder deposits.

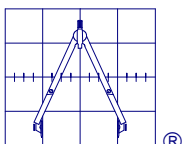

OGGIONI S.a.s. Via Laboratori Autobianchi, 1 - 20832 DESIO (MB) Italy
Tel. +39 0362 629135 Fax.+39 0362 622531 e-mail: info@oggionisas.com
On-line support techsupport@oggionisas.com - web: www.oggionisas.com



Performing paintings or insulation operations with foaming agents, in the area where the sensors are installed it is recommended to adequately protect the devices and never expose them to solvents or substances that may affect the proper operating of the devices.

After exposure to a high concentration of gas (close to or greater than the full scale) always check the sensitivity of the sensor by running a calibration test.

Always remember that the only sure method to check the proper operating of the transmitters is to perform a calibration test using a gas mixture of calibration gas having a known concentration.

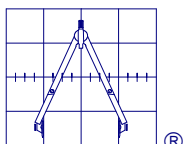

OGGIONI S.a.s. Via Laboratori Autobianchi, 1 - 20832 DESIO (MB) Italy
Tel. +39 0362 629135 Fax.+39 0362 622531 e-mail: info@oggionisas.com
On-line support techsupport@oggionisas.com - web: www.oggionisas.com



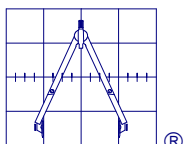

OGGIONI S.a.s. Via Lavoratori Autobianchi, 1 - 20832 DESIO (MB) Italy
Tel. +39 0362 629135 Fax.+39 0362 622531 e-mail: info@oggionisas.com
On-line support techsupport@oggionisas.com - web: www.oggionisas.com



I INTRODUCTION

1.1 General Description

The RAS series transmitters are designed and manufactured in compliance with the safety and health requirements as defined in Annexe II° of Directive 94/9/CE.

To meet the requirements of the directive the following harmonized European standards have been used:

EN 60079-0: 2009-08

EN 60079-1: 2007-07

The enose[®] AD transmitters are designed to measure concentrations of combustible gases in the range of 0-100% Lower Explosive Limit (LEL) or concentrations of toxic gases, in ppm range, in an atmosphere generally consisting of air.

The transmitters use our enose[®] technology which thanks to the extreme integration of the components, allows the mounting of all the transmitter parts, directly inside the transmitter probe body, giving the instrument a high degree of reliability and strength.

The extreme modularity of this technology allows the usage of sensors in various technologies: NDIR (infrared), Catalytic, Pellistor, Electrochemical Cell and MOS.

The transmitters can be supplied with relay outputs that can be associated to the alarm and fault conditions and with a display, having this way an autonomous measurement station, remote.

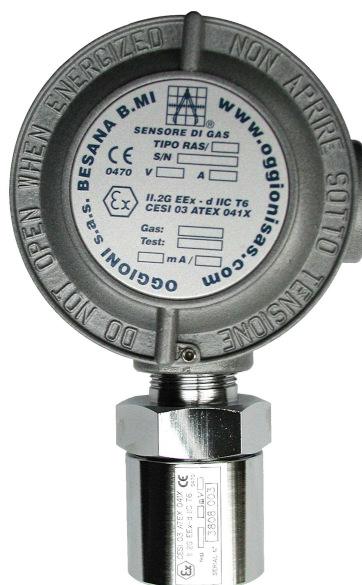
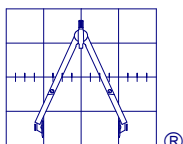

Fig. 1.1.1 RAS AD version



OGGIONI S.a.s. Via Lavoratori Autobianchi, 1 - 20832 DESIO (MB) Italy
Tel. +39 0362 629135 Fax.+39 0362 622531 e-mail: info@oggionisas.com
On-line support techsupport@oggionisas.com - web: www.oggionisas.com



Atex Certified

1.2 Features

The RAS/AD enose[®] transmitters have been designed in compliance with the requirements of ATEX 94/9/CE Directive concerning the fixed gas detection systems.

The gas transmitters are controlled by a microprocessor, they have a 4-20 mA analogue output, or three relay outputs with voltage free contacts that can be associated to the alarm or fault conditions. These transmitters also have a communication serial line RS-485 with Modbus RTU protocol for the operation of diagnosis and maintenance.

Small size
 Low Power consumption
 Non Intrusive "One Person" calibration.
 Very resistant to poisoning substances.

The RAS detectors meet the requirement of the ATEX 94/9/CE directive, including functional performances, they are also conform to SIL 2, being this way suitable to be apart of security systems

1.3 Typical Application

Ideal to detect combustible gas and solvents, the typical application field of the RAS transmitters are:

Chemical and Petrochemical Industry
 Gas treatment, storage and distribution plants
 Combustible material storage

II SPECIFICATION

2.1 General specification

Used Sensor Technologies	NDIR (Infrared) - type RAS/AD/2xx/.. Catalytic / Pellistor - type RAS/AD/1xx/.. Electrochemical Cell - type RAS/AD/3xx/.. MOS (Semiconductor) - type RAS/AD/4xx/..
Code of protection	⚡ II 2G Ex-d IIC T6
IP Rating	IP65
Location	Hazardous area (zone 1)
Short-term repeatability	±2% FSD 60 min.
Long-term repeatability	±5% FSD 3 months
Accuracy	±5% FSD
Response time	T ₉₀ ≤ 20 seconds ; T ₅₀ ≤ 10 seconds *(methane)

* reference mixture used (CH₄), for other gas or vapors response time may be longer

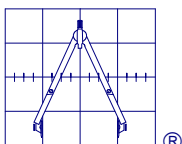

OGGIONI S.a.s. Via Lavoratori Autobianchi, 1 - 20832 DESIO (MB) Italy
 Tel. +39 0362 629135 Fax.+39 0362 622531 e-mail: info@oggionisas.com
 On-line support techsupport@oggionisas.com - web: www.oggionisas.com



2.2 Electrical Specification

Supply Voltage	12-30 Vdc
Power consumption	IR Combustible sensors: 140mA@13.5V; 80mA@24V Catalytic combustible sensors : H.Q. sensor – 140mA@13.5V; 80mA@24V Standard sensor – 75mA@13.5V; 55mA@24V Oxygen/Toxic sensors: 60mA@13.5V; 40mA@24V MOS sensors: 100mA@13.5V; 70mA@24V Relays Configuration: +20mA@13.5V; +10mA@24V every energized relay, for a maximum of 3 relays
Supply fuse	500 mA
Signal fuse	63 mA
Analogue output	4-20 mA
Load	0-300 ohms
Cable Type	4-20mA: 3 conductor shielded cable Relays: 2 conductor
Relays	2 relays for Warn / Alarm 1 Fault relay Programmable for normally energised/de-energised, with manual/automatic reset Max. contact resistance 150 mΩ Max. switching voltage 100Vdc Max. switching current 1A

2.3 Environmental Specification

EMC susceptibility	According to EN 50270; EN 61000-6-3
Storage temperature	-20 to +40 °C
Operating temperature	-40 to 70 °C -20 to 50°C - for electrochemical cells only
Humidity range	90% R.H. n.c.
Pressure range	80-120kPa
Air speed	0 – 6 m/s

2.4 Mechanical Specification

Overall dimensions	170x100x70 mm
Weight	0.4 Kg
Mounting	2x6 mm holes
Termination	Gland Ex-d
Junction box attachment	3/4" Conical Thread UNI 6125 – ISO 7/1 Rc

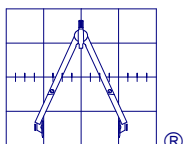

OGGIONI S.a.s. Via Laboratori Autobianchi, 1 - 20832 DESIO (MB) Italy
 Tel. +39 0362 629135 Fax.+39 0362 622531 e-mail: info@oggionisas.com
 On-line support techsupport@oggionisas.com - web: www.oggionisas.com



Atex Certified

2.5 Ordering information

The RAS detectors may have various output configurations according to the application requests. In brief, the coding below, groups together the various options.

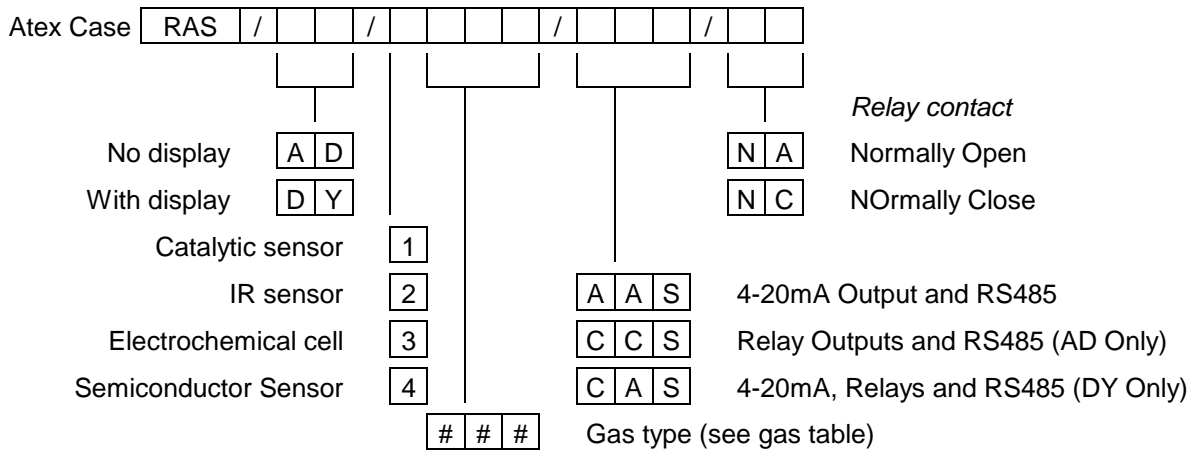

2.6 Outline drawing

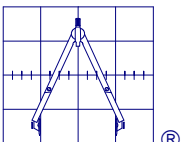
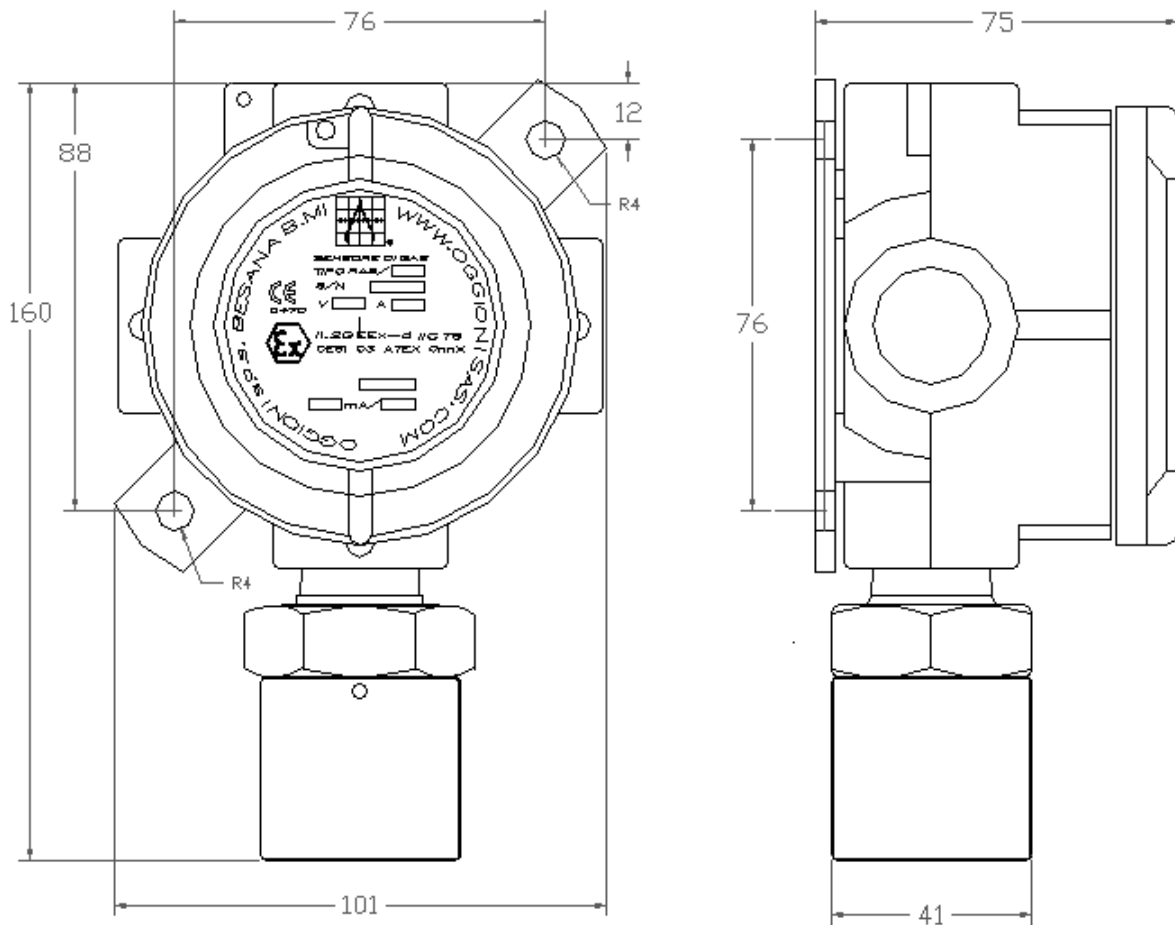

OGGIONI S.p.A. Via Laboratori Autobianchi, 1 - 20832 DESIO (MB) Italy
 Tel. +39 0362 629135 Fax.+39 0362 622531 e-mail: info@oggionisas.com
 On-line support techsupport@oggionisas.com - web: www.oggionisas.com



III INSTALLATION

The installation of the transmitters must be performed in accordance with European Standard EN 60079-14 or in accordance with national normative.



Installation must be carried out by well skilled and competent personnel only.
Site the sensors to facilitate recalibration and maintenance routine.
Always mount the sensors vertically with the detection head facing downwards and the cable entry on top.

3.1 Sensor Location Guidelines

The first factor to consider when deciding where to position the sensors is the type of gas that has to be detected.

Normally, for gases with a lower density than the air (hydrogen, methane, etc.), the sensors are uniformly distributed at about 30cms from the highest point of the ceiling, because these "light" gases are easily defused in the air.

It is as well good practice to avoid places where there are air currents or where the air is likely to be very still because of certain irregularities of the ceiling e.g. beams etc. which stop the gas freely moving around.

For gases with higher density than the air the sensors should be placed near the floor (about 30cm high) and in proximity to possible air vents.

Particular points such as airspaces, junction boxes, manholes, and weigh-bridges should always be controlled by a sensor.

For gases with a specific weight similar to the air or for toxic substances in low concentration it is a good general rule to distribute the sensors at different levels to heighten the chances of intercepting an eventual leak.

Always have the gas sensor head pointing downwards so that the gas inlet is protected from water and accumulation of dust and/or dirt. Site the sensors to facilitate recalibration and maintenance routine.

3.2 Generic wiring guidelines

The use of shielded cables is recommended to connect the sensor to the power supply unit. Should more than one strand of wire be used in the wiring be sure that the cable screen is continuous and that the conductors are soldered at the joints.

The cable screen must be connected to safety grounding in safe area.

Furthermore it must be remembered that the protective shielding must be grounded only on the control unit or power supply side and should never be connected to the detector.

The use of terminal leads is recommended, or in any case joints on the power cable must be clamped with flat tab connectors or soldered.

Complete all cable insulation testing before connecting the cable at either end.
When all wiring has been completed and tested, the system may be powered-up.

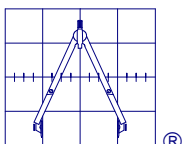

OGGIONI S.a.s. Via Laboratori Autobianchi, 1 - 20832 DESIO (MB) Italy
Tel. +39 0362 629135 Fax.+39 0362 622531 e-mail: info@oggionisas.com
On-line support techsupport@oggionisas.com - web: www.oggionisas.com



The following table gives a guide about the wire section depending on the distances.

Distance Km	AWG Section	mm ² Section
<1	17	1
1.5	15	1.6
2.5	13	2.5

3.3 Guide lines for proper installation according to EMC Directive

To comply with EN 50270 EMC (Electromagnetic Compatibility), you have to observe some simple points during the installation.

In General:

The area chosen to instal the detectors must be free from strong electromagnetic interferences.

Eventual autonomous power supply sources powering the detectors must be equipped with line filters type FN 660 (Schaffner) or equivalent or in any case in accordance with the EMC Directive

To connect the input devices it is recommended to use shielded cables with a minimum cover of 80%.

It is recommended to avoid connecting inductive or capacitive loads, that could generate transient on the system power supply, to the same power supply source used for the detectors.

If actuators, sirens or other devices secondary power supply is necessary, it is recommended to use a separate winding on the secondary of the transformer of main power supply.

The electrital power supply must be properly connected to the grounding.

3.4 General precautions

- Do not paint the the sensor head or the transmitter body.
- At start up always verify the transmitter response using a mixture of known gas
- Do not expose the transmitter to electrical and/or mechanical shocks.
- Make sure that the sensor has a good exposure to the atmosphere maintaining the sintered head filter clean and free of condensation
- Any repairs or tecnical operation on the transmitter must be performed only by athorized Oggioni s.a.s. personnel

3.5 Storage

The gas detectors must be stored in clean areas, not humid and always in the temperature range conforming the indications of the tecnica specifications.

In case of prolonged storage, the detectors must be into their original packing and they have to be sealed in plastic bags containing if possible a drying agent.

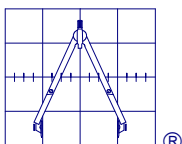

OGGIONI S.a.s. Via Lavoratori Autobianchi, 1 - 20832 DESIO (MB) Italy
Tel. +39 0362 629135 Fax.+39 0362 622531 e-mail: info@oggionisas.com
On-line support techsupport@oggionisas.com - web: www.oggionisas.com



3.6 Cable connection guidelines

The RAS/AD gas detectors must be connected according to the configuration you have as specified here below. In the following tables the available RAS/AD configurations with their connections are described:

a) 4-20mA with serial line RS485 version RAS/ AD/... / AAS

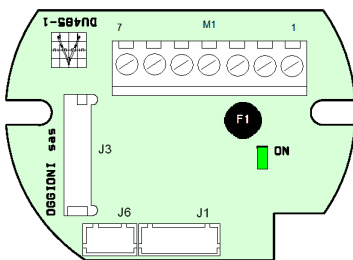

Terminal pins	Signal	Description
1	(-)	Negative
2	+12÷24VDC	Power supply (Positive)
3	4-20mA	Analogue output
4	(-)	Negative
5	A	A RS-485
6	B	B RS-485
7	Shield	Cable shield

b) RS485 serial line and 3 relays version RAS /AD/... / CCS

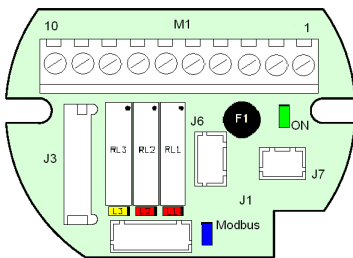

Terminal pins	Signal	Description
M1 Connector		
1	(-)	Negative
2	+12÷24VDC	Power supply (Positive)
3	N/U	Not Used
4	NO/NC	First alarm threshold
5	Common	First alarm threshold
6	NO/NC	Second alarm threshold
7	Common	Second alarm threshold
8	NO/NC	Fault
9	Common	Fault
10	Shield	Cable shield
Terminal pins		
J7 Connector		
	A	A RS-485
	B	B RS-485
LED Indications		
ON	Green	Power on
L1	Red	First alarm threshold
L2	Red	Second alarm threshold
L3	Yellow	Fault
Modbus	Blue	RS-485 communication status

NOTE:

All three relays are featuring one single contact only. Therefore while the relay is not activated the contact will remain open (N.O.) and LEDs will be OFF.

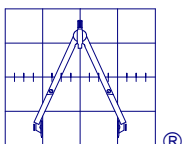

OGGIONI S.a.s. Via Lavoratori Autobianchi, 1 - 20832 DESIO (MB) Italy
 Tel. +39 0362 629135 Fax.+39 0362 622531 e-mail: info@oggionisas.com
 On-line support techsupport@oggionisas.com - web: www.oggionisas.com



With the relay energized the contact will be closed and its related LED will be ON. So, should the relays be programmed as normally energized, the related contacts will be closed in normal operation and relative LED will be ON, and they will open when the associated event occurs (Alarm, Fault) or in case of main power interruption and related LED will automatically switch OFF.

Relays alarm thresholds are programmed during production by the manufacturer on customer request and can be modified only by connecting the gas detector to a PC using a specific software called "enoseBlu2" (see enoseBlu2 software Instruction Manual for relays alarm thresholds modification procedure).

c) Remote display configuration

If necessary, it is possible to add a DY-28 remote display to the gas detector. In this case the connections between the gas detector and the display unit shall be done as indicated in the picture.

The power electrical connections and the 4-20mA signal between the two units shall be done through the gas detector's M1 terminal and the J1 connector of the DY-28 display unit.

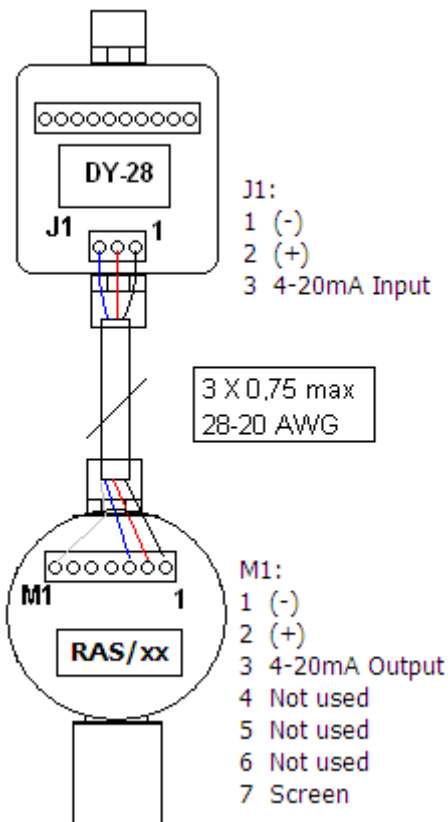

Pin J1 DY-28 display unit pin J1 assignment:

Terminal pins	Signal	Description
J1 Connector		
1	(-)	Negative
2	+12÷24VDC	Power supply
3	4-20mA	Analogue Output

For further information please see the DY-28 manual

N.B.: The remote display can only be connected with an AAS detectors main board, as the 4-20mA output is requested on the main board.

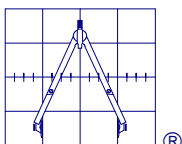

3.7 Final inspection and Start Up

Complete all cable insulation testing before connecting the cable at both ends.

The CABLE SHIELD must be isolated and it must NOT BE CONNECTED TO THE ELECTRONIC CIRCUIT OF THE GAS DETECTOR.

After all the wiring has been connected and completely tested, the detector must be closed, and only after this the system can be powered on.

In case of output relays version (RAS/AD/.../CCS), during the warm up time the Fault relay will be active (showing the Fault condition) and, when the warm up procedure will successfully finish, the Fault relay will return to its normal position.

In case the gas detector is faulty, the Fault relay will stay in fault condition (showing the effective fault event) even after the warm up time has elapsed.

After the warm up procedure, in normal operation status, the instrument analogue output must have the 4 mA value.

3.8 Fault conditions and Actions

Fault or malfunction conditions are indicated by the detector by activation of fault relay (for CCS version) or giving the value of 2mA on the analogue output signal (for AAS version).

The following table gives indication of fault conditions and possible actions:

Condition	Mode	Actions
Power up	Automatic reset	Wait for end of start-up cycle, about 1 minute
Start Up Fail	Latching (manual reset)	Switch the instrument OFF and ON again, if problem is not solved check sensor status and if necessary replace it
Sensor fault	Latching (manual reset)	Check sensor status and if necessary replace the sensor
EEPROM CRC Error	Latching (manual reset)	Restart the instrument, if problem is not solved send the instrument back to the supplier
Calibration Error	Latching (manual reset)	Try to make a new calibration, if problem is not solved replace the sensor
Over Range	Automatic reset	Check absence of gas in ambient, switch the instrument OFF and ON again, if problem is not solved check sensor status and if necessary replace it
Sensor negative drift	Automatic reset	Restart the instrument or make a new zero calibration

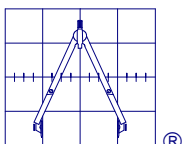

OGGIONI S.a.s. Via Lavoratori Autobianchi, 1 - 20832 DESIO (MB) Italy
 Tel. +39 0362 629135 Fax.+39 0362 622531 e-mail: info@oggionisas.com
 On-line support techsupport@oggionisas.com - web: www.oggionisas.com



IV TEST AND VERIFICATION

The instrument is factory calibrated for one specific gas.

It is recommended to periodically check the sensor response according to the EN60079-17 using the test and calibration appropriate kit.

To verify the gas detector calibration, follow the instructions below:

Mount the GDA-FA-2 adapter on the gas detector GM2 sensor head and connect the flexible pipe to the regulator mounted on the gas cylinder.

Connect a multimeter (with 20mA scale) in series to the 4-20mA signal; on the multimeter you shall read 4mA in normal conditions.

If the gas detector has relays output only (CCS version), you will just check the relays being activated when reaching the set alarm threshold giving gas from the test gas bottle.

Slowly open the gas cylinder regulator to have a test gas flow not greater than 0,5 l/min. and maintain it constant.

The read current on the multimeter will increase until the maximum value is reached and then the readout gets stable.

This step should take about 1 min, check continuously the 4-20mA output with a multimeter during the complete procedure.

The test is passed if the output in mA will reach the value correspondent to the gas concentration contained into the test gas bottle. An acceptable reading is included between 90% and 120% of test gas concentration.

If the gas detector only has relays output (CCS version), you will see the relays activating when the read concentration reaches the set alarm threshold (relays will change their status and you will see red LED switching ON or OFF according to the configuration requested – if normally energized or normally not energized at rest).

After the test is finished, close the gas flow and remove the gas detector sensor head adapter.

It is recommended to perform a gas detectors functional test every six months according to the operation instructions related to the used sensor type.



WARNING: If you are working in a classified explosion hazardous area make sure you are taking all the necessary precautions before you open the gas transmitter body. This operations can only be performed by qualified and trained personnel.

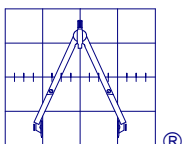

OGGIONI S.a.s. Via Laboratori Autobianchi, 1 - 20832 DESIO (MB) Italy
Tel. +39 0362 629135 Fax.+39 0362 622531 e-mail: info@oggionisas.com
On-line support techsupport@oggionisas.com - web: www.oggionisas.com



V CALIBRATION

It is recommended to check every three months the sensor response using the test and calibration appropriate kit.

To make a correct calibration, the following instruments are requested:

Calibration kit with adaptor for GM2 head.

Cylinder with test gas with known concentration (preferably with a concentration of 50% of the detector full scale).

Magnet to start Calibration procedure.



Before starting any verification and calibration procedure all personnel responsible for security must be informed and all alarm systems which might be connected to the system must be switched off.

5.1 ZERO Calibration



Fig. 1
Starting from this position, slowly move the magnet until reaching the final position in Fig. 2



Fig. 2
From this position remove the magnet and the zero calibration procedure is terminated.

5.2 SPAN Calibration

To start the span calibration, mount the adapter to the GM2 sensor head and connect it to the pipe of the gas cylinder via the rapid plug as in the picture.

Start the calibration procedure following the steps below. It can be done in two ways:

- blindly, see subchapter 5.2.1.
- checking the 4-20mA output with a multimeter during the procedure (see subchapter 5.2.2.).

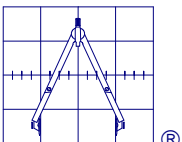

OGGIONI S.a.s. Via Lavoratori Autobianchi, 1 - 20832 DESIO (MB) Italy
Tel. +39 0362 629135 Fax.+39 0362 622531 e-mail: info@oggionisas.com
On-line support techsupport@oggionisas.com - web: www.oggionisas.com



Atex Certified

5.2.1 Span calibration with relay outputs (CCS)

This procedure consists of the following steps :

Switch off all the alarm systems that might be connected to the gas detection system, informing all the security personnel and responsible.

Place the calibration magnet on the left side of the sensor (as shown in figure 1) and slowly move the magnet 120° to the right (as shown in figure 2) the PreAlarm red LED will switch on showing the reading of the magnet, suddenly turn the magnet left (before the red LED switches off again) to put it back to the start position.

The PreAlarm red LED switches off, wait for about 40 seconds until the Alarm red LED switches on (if after about 40 seconds the LED doesn't switch on, the calibration procedure didn't start so repeat the sequence with the magnet).

Remove the magnet from the instrument head. In this moment the detector enters the span calibration status.

Slowly open the gas cylinder adapter valve until you have a flow not greater than 0,5 l/min. and maintain a constant gas flow for about 60". Now the read value should be stable. After about 60 seconds close the adapter valve.

Wait until the red LED switches off, in this moment the span calibration procedure is finished. If the Fault yellow LED changes its status (Fault condition) the calibration failed, so repeat all the procedure from the beginning. If the fault condition remains, please see par. 3.6

Remove the adapter from the gas detector's head and switch on again all the alarm systems connected to the gas detection system.

5.2.2 Span calibration using an multimeter

Disable all alarm outputs on the central unit, put the calibration magnet on the left side of the sensor, (as shown in figure 1) and slowly move the magnet 120° to the right, (as shown in figure 2), wait few seconds and then bring the magnet in the start position to the left again.

Connect a multimeter (with 20mA full scale) in series to the 4-20mA signal.

On the ampermeter you shall read as follows:

Just after removing the magnet : the current will go down from 4mA to 1mA and will remain steady for about 20s.

After the 20s, the expected calibration value will be shown, (by default at 12mA, that corresponds to 50% of the full scale).

This value may be changed by the operator, should the calibration bottle concentration have a different value. (See the NOTES below).

This value will be stable for about 20s.

After the 20s the detector will show the real gas value read, then the multimeter will read 4mA.

Slowly open the valve of the adaptor until you have a flow no greater than 0,5 l/min. and maintain a constant flow of test gas. The read current will increase until the maximum value will be reached and the readout will get stable. This step takes about 1 min.

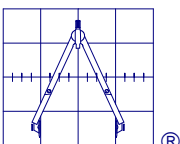

OGGIONI S.a.s. Via Lavoratori Autobianchi, 1 - 20832 DESIO (MB) Italy
Tel. +39 0362 629135 Fax.+39 0362 622531 e-mail: info@oggionisas.com
On-line support techsupport@oggionisas.com - web: www.oggionisas.com



After about 1 minute close the gas flow and take off the adapter from the GM2 sensor head. As soon as the gas read decreases below 80% of the highest read value, the detector will set the span. The highest value read will be assigned to the expected span value. While doing this, the value in mA read on the ampermeter's display will drop to 1 mA.

This step takes about 20s, then the instrument will turn back to the real gas value in that moment. Considering the gas may be still inside the sensor head, the operator will probably read a current value dropping towards 4 mA.

WARNING!! If the calibration procedure fails, the multimeter will measure 2 mA. In this case switch off the power, then power on again, wait for the detector warm up time and then repeat the calibration procedure.

Eventually, after the 4-20 mA output gets stable to 4 mA again (detector reading gets to zero again), it is recommended to check the calibration applying gas again from the bottle and checking the read value.

NOTES – Changing the expected span gas (calibration gas concentration):

To change the expected span span (calibration gas concentration), as soon as the 12mA value is read on the multimeter, put the magnetic tool on the sensor head again (in central position) and keep it still, the value of the expected gas concentration will start increasing. When the desired expected span value has been reached, the magnet must be removed.

If the desired value is lower than the default 50%, one should keep the magnet on until the full scale is reached, after which the counting will start over from zero again. Then, when the desired expected value has been reached, the magnet can be removed.

A previous calculation is necessary to find the current value corresponding to the expected desired span concentration, according to the detector full scale, and considering the following remarks:

The scale in current goes from 4mA corresponding to zero gas (fresh air) to 20mA corresponding to the detectors full scale.

Therefore there will always be a delta of 16mA from zero to full scale value.

$$100\% f.s. : 16mA = 30\% f.s. : x$$

Then:

$$x = 30 * 16 / 100 \text{ that is } x = 4.8 \text{ mA}$$

The expected current value for a concentration of 30% of full scale will therefore be:

$$4.0 \text{ mA} + 4.8\text{mA} = 8.8\text{mA}.$$

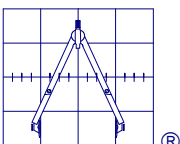

OGGIONI S.a.s. Via Lavoratori Autobianchi, 1 - 20832 DESIO (MB) Italy
 Tel. +39 0362 629135 Fax.+39 0362 622531 e-mail: info@oggionisas.com
 On-line support techsupport@oggionisas.com - web: www.oggionisas.com



Table 1 – Response time various sensors

Gas	Formula	Sensor Technology	Standard Range	Response T50	Response T90
Flammable		Standard Catalytic	0 - 100% LEL	n.a.	< 10 sec.
		High Qualità Catalytic	0 - 100% LEL	n.a.	< 10 sec.
		Infrared	0 - 100% LEL	n.a.	< 30 sec.
Various		MOS	Various	n.a.	< 10 sec.
Oxygen	O2	Electrochemical cell	0 - 30% Vol.	n.a.	< 15 sec.
Carbon Monoxide	CO	Electrochemical cell	0-300/500 ppm	< 10 sec.	< 30 sec.
			0-500/1500 ppm with H2 and SO2 filter	< 10 sec.	< 30 sec.
Carbon Dioxide	CO2	Infrared	0 - 10000 ppm	n.a.	< 30 sec.
			0 - 5% Vol.	n.a.	< 30 sec.
			0 - 100% Vol.	n.a.	< 30 sec.
Hydrogen Sulfide	H2S	Electrochemical cell	0 - 30 ppm	< 15 sec.	< 30 sec.
			0 - 100 ppm	< 15 sec.	< 30 sec.
Hydrogen	H2	Electrochemical cell	0 - 1% Vol.	< 40 sec	< 70 sec.
			0 - 4% Vol.	< 40 sec.	< 60 sec.
Nitric Dioxide	NO	Electrochemical cell	0 - 100 ppm	< 10 sec.	< 20 sec.
Nitrogen Dioxide	NO2	Electrochemical cell	0 - 50 ppm	< 10 sec.	< 30 sec.
Ammonia	NH3	Electrochemical cell	0 - 100 ppm	< 20 sec.	< 60 sec.
			0 - 500 ppm	< 30 sec.	< 90 sec.
			0 - 1000 ppm	< 20 sec.	< 90 sec.
			0 - 5000 ppm	< 30 sec.	< 90 sec.
Hydrogen Cyanide	HCN	Electrochemical cell	0 - 30 ppm	< 25 sec.	< 50 sec.
Hydrogen Chloride	HCl	Electrochemical cell	0 - 30 ppm	< 30 sec.	< 70 sec.
Hydrogen Bromide	HBr	Electrochemical cell	0 - 30 ppm	< 30 sec.	< 70 sec.
Chlorine	Cl2	Electrochemical cell	0 - 10 ppm	< 30 sec.	< 60 sec.
			0 - 50 ppm	< 20 sec.	< 60 sec.
Sulphure Dioxide	SO2	Electrochemical cell	0 - 20 ppm	n.a.	< 25 sec.
Silane	SiH4	Electrochemical cell	0 - 50 ppm	< 10 sec.	< 60 sec.
Boron Trifluoride	BF3	Electrochemical cell	0 - 10 ppm	< 30 sec.	< 90 sec.
Hydrogen Fluoride	HF	Electrochemical cell	0 - 10 ppm	< 30 sec.	< 90 sec.

NOTE: the above declared response times are the one declared by the sensor manufacturers, for the nude sensor without considering a flame arrester.

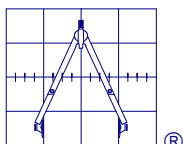

OGGIONI S.a.s. Via Lavoratori Autobianchi, 1 - 20832 DESIO (MB) Italy
 Tel. +39 0362 629135 Fax.+39 0362 622531 e-mail: info@oggionisas.com
 On-line support techsupport@oggionisas.com - web: www.oggionisas.com



Atex Certified

VI MAINTENANCE

Safety Warning



Installation and maintenance must be performed only by trained, skilled and competent personnel.

Before starting any maintenance procedures, all responsible security personnel should be informed and all alarm systems which might be connected to the system should be switched off.

This instruments need a routine maintenance, including calibration on a regular basis. It is recommended a complete system check-up at least once a year.

Check (possibly every three months) the sensor response using known gas concentration and recalibrate it every 6 months if necessary.

Make sure the atmosphere is clean and free of other gases before proceeding with the calibration and always use certified gas mixture bottles and never after the expiration date (every bottle has an expiration date).

The detector is provided with a sintered filter that during the operation may clog due to water, dust, oil etc. Check the filter by removing it and clean it with compressed air if necessary before refitting it. **(blow the compressed air from the inner side to the outer side of the cap and never vice versa).**

DO NOT USE COMPRESSED AIR ON SINTERIZED FILTERS WHILE FIT ON THE DETECTOR HEAD!

At the end of the maintenance and/or inspection update the plant register, making sure to keep records of the actions taken and the new calibration parameters.

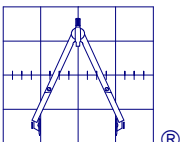

OGGIONI S.a.s. Via Laboratori Autobianchi, 1 - 20832 DESIO (MB) Italy
Tel. +39 0362 629135 Fax.+39 0362 622531 e-mail: info@oggionisas.com
On-line support techsupport@oggionisas.com - web: www.oggionisas.com



VII MODBUS RTU Serial Interface

7.1 Introduction

The Modbus communications interface is based on the two wire half-duplex RS485 standard in conformity to the EIA-485 specification.

The Transmitter implements the RTU protocol, the RTU mode and serial format must be the same for all devices connected on the network.

The Modbus interface factory default are set as follow:

Address 127
 Baud rate 19k2
 Parity none
 Stop Bit 1

7.2 Modbus read command

- READ-MULTI-HR (cod. 03 dec. Read holding register)

7.3 Memory map

(Holding Registers)

REGISTER CATEGORY	MODBUS ADDRESS	NAME	UNIT	MEMORY	ACCESS LEVEL
DIAGNOSTIC	12	Warning Quantity	General	E2PROM	READ ONLY
DIAGNOSTIC	13	Alarm Quantity	General	E2PROM	READ ONLY
DIAGNOSTIC	14	Maximum Gas	One Tenth of milliAmp	E2PROM	READ ONLY
DIAGNOSTIC	54	SIL Level	General	E2PROM	READ ONLY
DIAGNOSTIC	74	ResetHW Counter	General	E2PROM	ADMIN
READING FROM SENSOR	6	Percent Gas	Percentage	RAM	READ ONLY
READING FROM SENSOR	7	Sensor Output	milliVolt	RAM	READ ONLY
READING FROM SENSOR	9	Detected Gas Quantity	One Tenth of milliAmp	RAM	READ ONLY
READING FROM SENSOR	10	FBack Gas Quantity	One Tenth of milliAmp	RAM	READ ONLY
READING FROM SENSOR	11	Temperature	One Tenth of Centigrade	RAM	READ ONLY

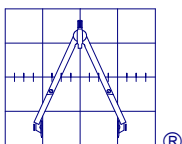

OGGIONI S.a.s. Via Lavoratori Autobianchi, 1 - 20832 DESIO (MB) Italy
 Tel. +39 0362 629135 Fax.+39 0362 622531 e-mail: info@oggionisas.com
 On-line support techsupport@oggionisas.com - web: www.oggionisas.com



Atex Certified

VIII MARKING AND CERTIFICATIONS

8.1 GM2 Probe Marking

 II 2G Ex d IIC T6

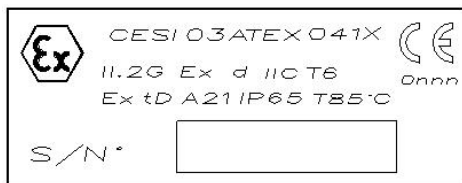

8.2 GM2 Probe certificates and reference standards

Manufacturer:	OGGIONI S.a.s. Via Gariberto da Besana,11 20045 Besana B. (MB) Italia.
Product:	Gas Transmitter series RAS
Type of protection:	EN 60079-0: 2009-08 EN 60079-1: 2007-07
Performance According to:	EN 61779-1:2007 EN 61779-4:2004
EMC Compliance According to directive 2004/108/EC	EN50270 Tipo2 EN 61000-6-3:2002
Test report:	AD-97/023215
EC type examination:	CESI 03 ATEX 041X

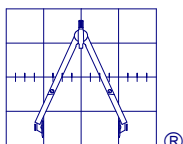

OGGIONI S.a.s. Via Lavoratori Autobianchi, 1 - 20832 DESIO (MB) Italy
Tel. +39 0362 629135 Fax.+39 0362 622531 e-mail: info@oggionisas.com
On-line support techsupport@oggionisas.com - web: www.oggionisas.com



8.3 Series S...-SO...Case Marking

 II 2GD Ex d IIC / Ex tD A21 IP66
Ta standard $-20^{\circ}\text{C} \leq T_a \leq +40^{\circ}\text{C}$
Ta estesa $-50^{\circ}\text{C} \leq T_a \leq +80^{\circ}\text{C}$

EC type examination: BVI 07 ATEX 0020U

8.4 Series S...-SO... Case certificates and reference standards

Manufacturer: COELBO s.r.l.
Via S.Margherita,83
20047 Brugherio (Mi)
Italia.

Product: Series S...-SO...Case

Type of protection: EN 60079-0: 2006 ; EN 61241-0:2006
EN 60079-1: 2004 ; EN 61241-1:2006

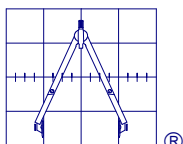

OGGIONI S.a.s. Via Lavoratori Autobianchi, 1 - 20832 DESIO (MB) Italy
Tel. +39 0362 629135 Fax.+39 0362 622531 e-mail: info@oggionisas.com
On-line support techsupport@oggionisas.com - web: www.oggionisas.com



Atex Certified

IX ACCESSORIES

Splash Guard

Cod. GDA - SD



Collector cone

Cod. GDA - CO



Sensor flow adaptor

Cod. GDA – FA/GM2



Portable calibration Kit

Cod. GDA – TK

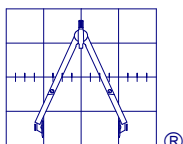

OGGIONI S.a.s. Via Lavoratori Autobianchi, 1 - 20832 DESIO (MB) Italy
Tel. +39 0362 629135 Fax.+39 0362 622531 e-mail: info@oggionisas.com
On-line support techsupport@oggionisas.com - web: www.oggionisas.com



Atex Certified

For more information please contact:

Oggioni s.a.s.
DESIO (MB)
Italy

Tel. + 39 0362 995062
Fax. +39 0362 622531
www.oggionisas.com
info@oggionisas.com



The brochure includes general specifications which are subject to change without prior notice.

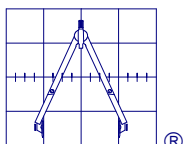

OGGIONI S.a.s. Via Lavoratori Autobianchi, 1 - 20832 DESIO (MB) Italy
Tel. +39 0362 629135 Fax.+39 0362 622531 e-mail: info@oggionisas.com
On-line support techsupport@oggionisas.com - web: www.oggionisas.com



Atex Certified